

Free eNewsletter

Enter your E-mail



Shop By Type

- Cable Assemblies
- Adapters
- Connectors
- Rack Panels
- Bulk Cable
- Tools
- Switch Boxes
- Network Cards
- Hubs & Switches
- Converters & Transceivers
- KVM Switches
- Antennas

- Overstock/Sale Items
- Top 10 Products

Shop By Category

- IEEE-488 GPIB
- Coaxial
- Monitor, Video
- Fiber Optic
- D-Subminiature
- Modular
- USB, DIN, Firewire, SCSI, and Others
- Wireless Infrastructure
- Weatherproof Enclosures
- Networking and Other Equipment

Product Wizards

- Cable Assemblies
- Adapters
- Connectors
- Rack Panels
- Tools
- Switch Boxes
- Network Cards
- Hubs or Switches
- Ethernet Converters
- KVM Switches

Technical Resources

- FAQs
- Connector Chart
- Glossary
- Tutorials
- Tips and Videos
- White Papers
- Catalog Downloads
- eNewsletter Archive

You Are Here: [Home](#) > [Modular](#) > [Adapters, Couplers, Splitters](#) > [Modular Couplers](#) > [ECF504- C, S](#) > **ECF504-8SK**

Modular Coupler, RJ45 (8x8K), Straight, 30µ

L-com's exclusive line of category 3 panel mount connectors is the perfect choice for passing modular cables through a rack panel or wall plate. The unique flange mount design accepts #4 or #5 screws for secure mounting of these couplers to any panel (purchased separately). Contacts have 30 microinches of gold plating for durability and the ivory plastic shell is UL94V-0 rated. With a category 3 rating these couplers can be used for either voice or data applications. Large volume discounts offered; Call today.



Features for this Modular product

- Category 3 RJ45 Panel Mount Coupler, USOC Straight or Cross-wired for voice or data applications
- Flange mount design accepts #4 or #5 screws for secure panel mounting
- 30 microinches gold plating for a durable connection
- UL94V-0 rated ivory plastic shell for ruggedness
- Category 3 rated for data and voice applications

Details for this Modular product

L-com Item #	ECF504-8SK
Manufacturer	L-com
ASIN # (More)	B000AAL6TY
UPC # (More)	822335022362
RoHS Status	RoHS Compliant (More)
Color	Ivory

- [Diagram](#)
- [Catalog Page](#)
- [2D Drawing \(.pdf\)](#)
- [3D CAD Model \(.step\)](#)

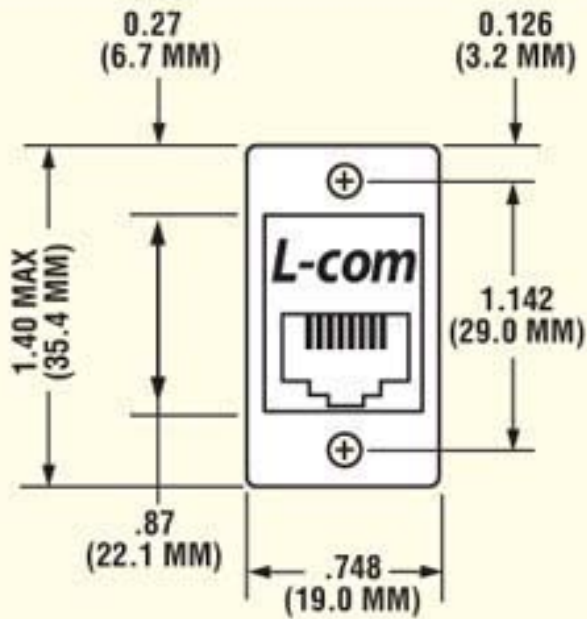

ECF & ECJ Front View

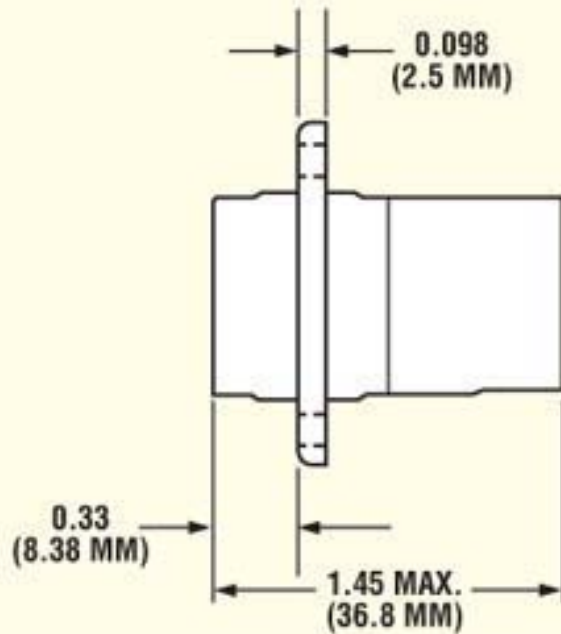

ECF Side View

USB Style Connectors

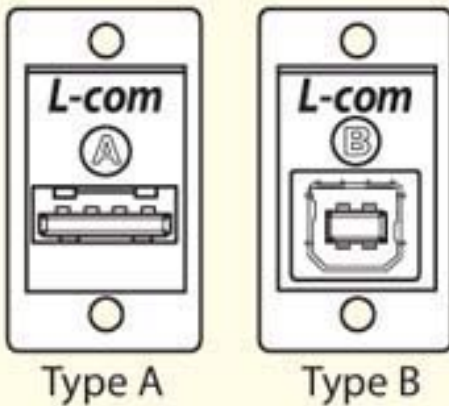

USB Type A & B

ECF & ECJ Series
RECOMMENDED PANEL HOLES

DRILL AND TAP HOLES FOR 4-40 SCREW

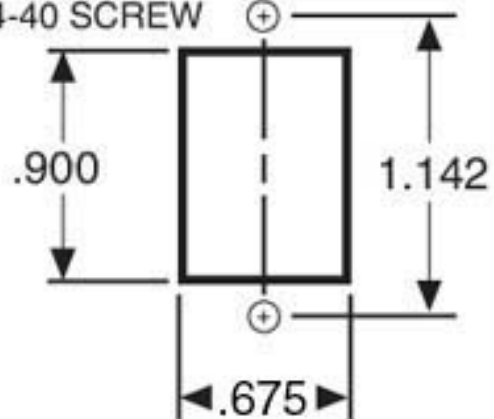

ECF504 Series



Network Rating: Category 3
Color: Ivory
Gold Plating: 30 microinches
Flammability Rating: 94V-0

ECJ504 Series Front View



ECJ504 Series Rear View

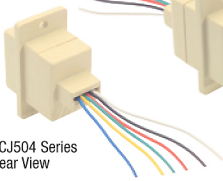

Color: Ivory
Gold Plating: 30 microinches
Flammability Rating: 94V-0

ECF504B Series



Network Rating: Category 3
Color: Black
Gold Plating: 50 microinches
Flammability Rating: 94V-0



PR175F504-6S

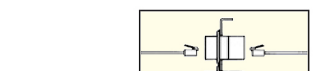

PR175F504-8SK



PR175F504-6C



PR175F504-8C



PR35F504-6S



PR35F504-8SK





PR35F504-6C



PR35F504-8C

Item #	Description	Color	1-9	10-24	25-99	100-249	250-499
 Deluxe Panel Mounted Modular Couplers, 30 Microinches Gold, Ivory Color							
ECF504-4C	Modular Coupler, RJ11 (6x4), Crossed, 30µ	Ivory					
ECF504-6C	Modular Coupler, RJ12 (6x6), Crossed, 30µ	Ivory					
ECF504-6CMJ	Modular Coupler, MMJ (6x6), Crossed, 30µ	Ivory					
ECF504-8C	Modular Coupler, RJ45 (8x8), Crossed, 30µ	Ivory					
ECF504-4S	Modular Coupler, RJ11 (6x4), Straight, 30µ	Ivory					
ECF504-6S	Modular Coupler, RJ12 (6x6), Straight, 30µ	Ivory					
ECF504-6SMJ	Modular Coupler, MMJ (6x6), Straight, 30µ	Ivory					
ECF504-8SK	Modular Coupler, RJ45 (8x8K), Straight, 30µ	Ivory					
ECF440	Machine Screws, 4-40 x 5/16", Pkg/100						

 Deluxe Panel Mounted Modular Jacks - 10" Wire Leads, 30 Microinches Gold, Ivory Color							
One difficulty in using modular jacks is the mounting problem on a panel. L-com's solution to this problem is providing a flange that mounts with two screws in a 0.675" x 0.900" rectangular opening. Choice of RJ11/12 (6x6) or RJ45 (8x8K) usable with keyed or non-keyed plugs. Custom versions of other jack types considered in quantities of 500/up. Mounting screws must be purchased separately.							
ECJ504-6	Modular Panel Jack, RJ12 (6x6) / Wires, 30µ	Ivory					
ECJ504-8	Modular Panel Jack, RJ45K (8x8K), / Wires, 30µ	Ivory					
ECF440	Machine Screws, 4-40 x 5/16", Pkg/100						

 Deluxe Panel Mounted Couplers, 50 Microinches Gold, Black Color							
These couplers are similar to the ECF504 Series with two changes. The molding has been changed to a black color for applications when ivory is not wanted. Also, the contacts have 50 microinches of gold for superior mating with modular plugs. Mounting screws must be purchased separately. Category 3 rated.							
ECF504B-4S	Modular Coupler, RJ11 (6x4), Straight, 50µ	Black					
ECF504B-6S	Modular Coupler, RJ12 (6x6), Straight, 50µ	Black					
ECF504B-8SK	Modular Coupler, RJ45K (8x8K), Straight, 50µ	Black					
ECF440	Machine Screws, 4-40 x 5/16", Pkg/100						

 19" Patch Panels - Equipped with 16 or 32 ECF504 Series Modular Couplers							
These 19" patch panels utilize the ECF504 series couplers. For your convenience, two panel heights are offered; 1.75" with 16 modular adapters or 3.5" with 32 modular adapters. Panel legend is 1-16 or 1-32. Color: Bone. Available in straight or crossed wiring.							
PR175F504-6S	1.75" 16 Port Panel RJ12 (6x6), Straight-Thru	Bone					
PR175F504-8SK	1.75" 16 Port Panel RJ45 (8x8), Straight, Keyed	Bone					
PR175F504-6C	1.75" 16 Port Panel RJ12 (6x6), Crossed	Bone					
PR175F504-8C	1.75" 16 Port Panel RJ45 (8x8), Crossed	Bone					
PR35F504-6S	3.50" 32 Port Panel RJ12 (6x6), Straight-Thru	Bone					
PR35F504-8SK	3.50" 32 Port Panel RJ45 (8x8), Straight, Keyed	Bone					
PR35F504-6C	3.50" 32 Port Panel RJ12 (6x6), Crossed	Bone					
PR35F504-8C	3.50" 32 Port Panel RJ45 (8x8), Crossed	Bone					

How Rack Spaces and Sizes are Measured

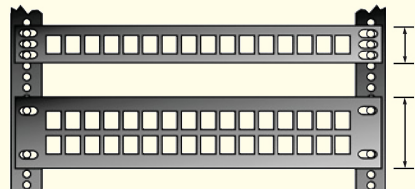

Racks are a great way to neaten up wiring closets and labs. Network equipment and rack panels usually come in 1.75", 3.5" and 5.25" heights. (1, 2 and 3 rack spaces).

 19" Modular Patch Panels - Equipped with 16 or 32 ECF504B Modular Couplers							
These panels utilize the ECF504B couplers with 50 microinch plating. 16 and 32 port available. Straight thru pinned only. Color: Black.							
PR175F504B-4S	1.75" 16 Port Panel RJ11 (6x4), Straight-Thru	Black					
PR175F504B-6S	1.75" 16 Port Panel RJ12 (6x6), Straight-Thru	Black					
PR175F504B-8SK	1.75" 16 Port Panel RJ45 (8x8), Straight, Keyed	Black					
PR35F504B-4S	3.50" 32 Port Panel RJ11 (6x4), Straight-Thru	Black					
PR35F504B-6S	3.50" 32 Port Panel RJ12 (6x6), Straight-Thru	Black					
PR35F504B-8SK	3.50" 32 Port Panel RJ45 (8x8), Straight, Keyed	Black					